

Montana

MONTANA SYSTEM

MONTANA ACADEMY

Table of contents

36 modules, 4 depths, 43 colours, endless possibilities

Expressing oneself is what Montana is all about. We aim to provide customers with endless opportunities to create, frame, and share their personal stories through thoughtful design and superior craftsmanship.



1.

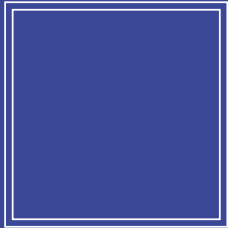

Size

Choose between 36 modules and 4 depths

2.

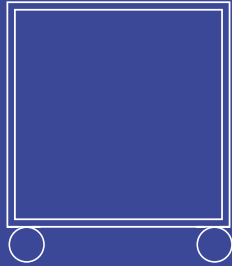

Position

Choose between positions; suspension rail, legs, plinth or castors

3.

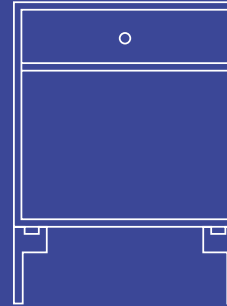

Customise

Choose between components; shelves, doors, drawers etc.

4.

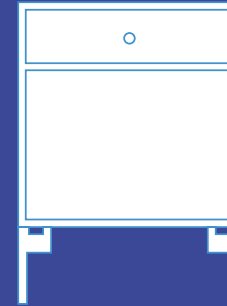

Colour

Choose between 41 water-based lacquer colours and 2 veneers. Colourise the entire module all at once or one component at a time

BASIC MODULES





Dimensions

Depth

Thickness

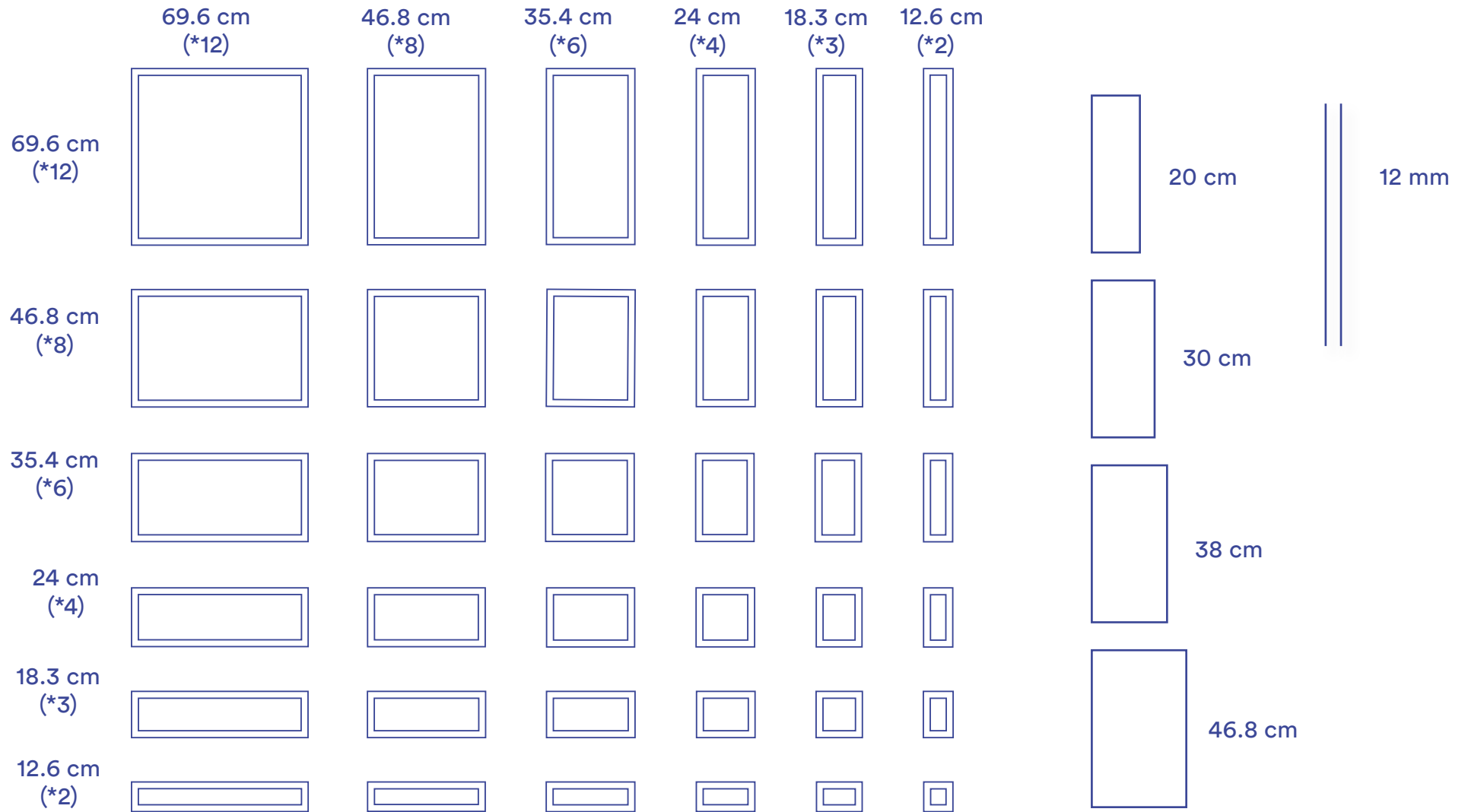



*Measurements	Inside	Outside
*1	4.5 cm	6.9 cm
*2	10.2 cm	12.6 cm
*3	15.9 cm	18.3 cm
*4	21.6 cm	24.0 cm
*5	27.3 cm	29.7 cm
*6	33.0 cm	35.4 cm
*7	38.7 cm	41.1 cm
*8	44.4 cm	46.8 cm
*9	50.1 cm	52.5 cm
*10	55.8 cm	58.2 cm
*11	61.5 cm	63.9 cm
*12	67.2 cm	69.6 cm
*16		93.6 cm
*18		105.0 cm
*20		116.4 cm

5.7

Using Montana's star system makes it easy to combine modules and components. 1 star (*) = 5.7 cm which is also the distance between the pilot holes.

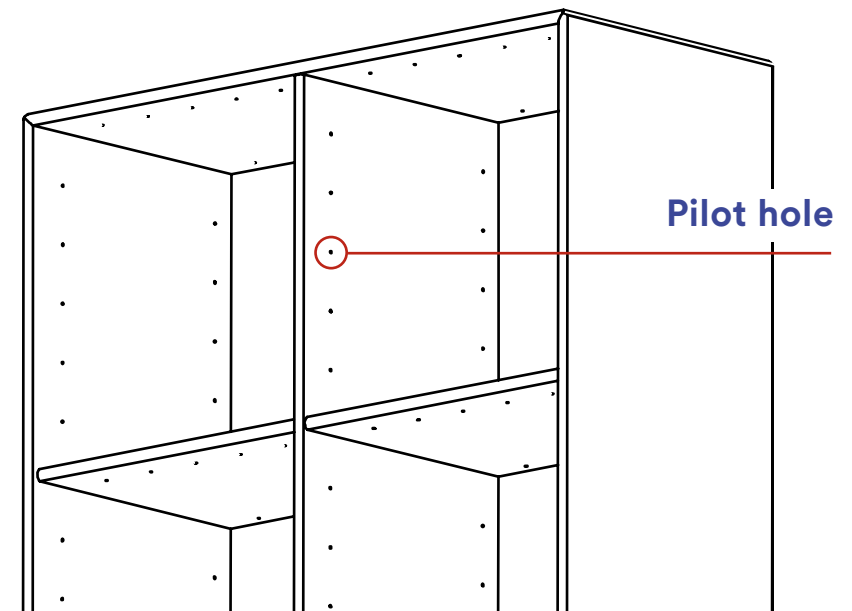



Pre-configured designs

An easy shortcut to your design classic

A wealth of components allows you to design your own personal Montana. In the price list and DesignPro, we have curated a selection of pre-configured designs to make it easier and quicker to work with the Montana system. Each basic module offers various designs with fixed components, but additional elements can always be incorporated. Depth, position, and colours are customised afterwards.





Unique product codes

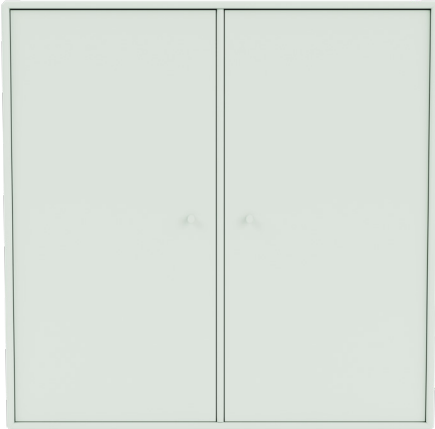

1118



1112

Montana has simplified purchasing the Montana System by offering a selection of pre-configured products. These unique product codes are available in the price list and in DesignPro.

It is possible to add components; however, components cannot be rearranged or removed from a product code, as this would result in a different product code.

The pre-configured products only require the depth, position, colour, and possibly additional components to be defined.



	*12	*12	*12	*12	*12	*12	*12	*12	
*12									
	1111	1112	1113	1114	1118 1118 P 1118 G 1118 R	1119	1120 1120 P 1120 G 1120 R	1121 1121 P	1122 1122 P
*12									
	1125 1125 P	1128 1128 P	1212	1218 1218 P 1218 G 1218 R	1220 1220 P 1220 G 1220 R	1221 1221 P	1222 1222 P	1223 1223 P	1224 1224 P
*12									
	1325 1325 P	1520 1520 P 1520 G 1520 R	1320 1320 P 1320 G 1320 R	1321 1321 P 1321 G 1321 R	1324 1324 P	1325 1325 P	1425 1425 P		
*12									
	1525 1525 P	1613	1615	1618 1618 P	1623 1623 P	1625 1625 P	1627		

Fixed shelf

Hidden shelf

P Push door

G Glass door

R Ripple glass







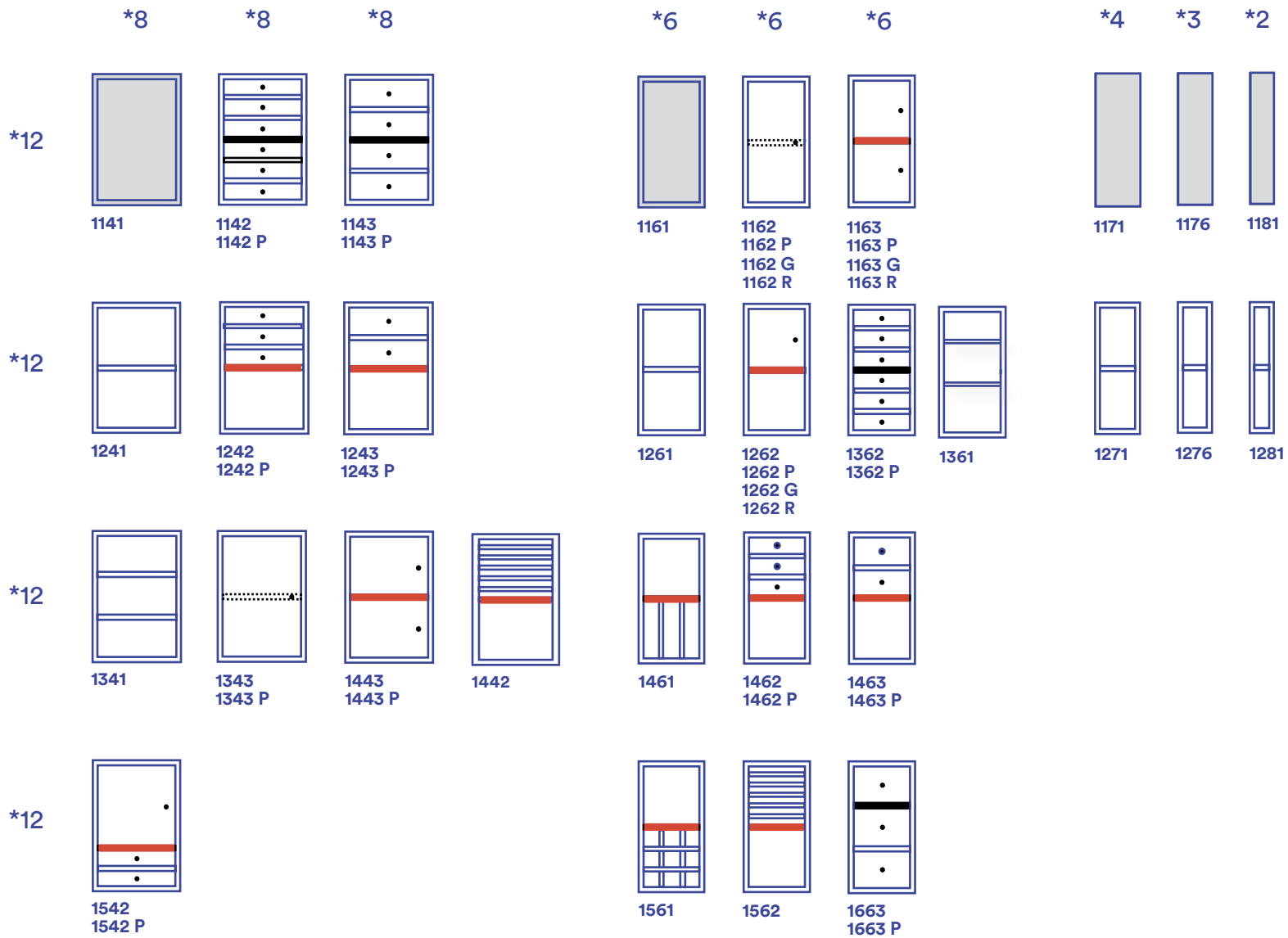





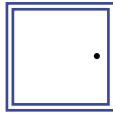
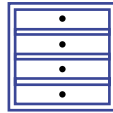
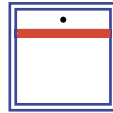

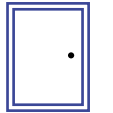
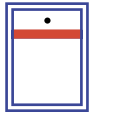



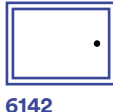





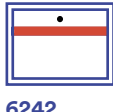











	*12	*12	*12	*12	*12	*12	*12	*12	
*8									
	4111	4112	4113	4120 4120 P 4120 G 4120 R	4122 4122 P	4123 4123 P	4124 4124 P	4125 4125 P	
*6									
	6111	6112	6113	6120 6120 P 6120 G 6120 R	6118 6118 P 6118 G 6118 R	6122 6122 P	6125 6125 P	6223 6223 P	6224 6224 P
*4									
	7111	7112	7122 7122 P	7123 7123 P	7124 7124 P	7125 7125 P			
*3									
	7611	7612	7624 7624 P	7625 7625 P					
*2									
	8111	8112	8122 8122 P	8123 8123 P					

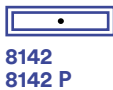

- Fixed shelf
- Hidden shelf
- P Push door
- G Glass door
- R Ripple glass



- Fixed shelf
- Hidden shelf
- P Push door
- G Glass door
- R Ripple glass



	*8	*8	*8	*8	*6	*6	*6	*4	*3	*2
*8	 4141	 4143 4143 P 4143 G	 4241 4241 P	 4242 4242 P	 4161	 4163 4163 P 4163 G 4163 R	 4262 4262 P	 4171	 4176	 4181
*6	 6141	 6142 6142 P			 6161	 6163 6163 P 6163 G 6163 R		 6171	 6176	 6181
*6	 6241 6241 P	 6242 6242 P			 6261 6261 P	 6262 6262 P	 6264 6264 P			
*4	 7141	 7142 7142 P			 7161	 7162 7162 P		 7171	 7176	 7181
*3	 7641				 7661			 7671	 7676	 7681
*2	 8141	 8142 8142 P			 8161	 8162 8162 P		 8171	 8176	 8181

-  Fixed shelf
-  Hidden shelf
- P Push door
- G Glass door
- R Ripple glass



Bar unit, Secrétaire & Studio

The unit is always supplied with a suspension rail for wall mounting. A shelf can be fitted behind the drop front of the secrétaire units in *2, *3, *4, and *5 positions from the top in a depth of 38 cm. Shelves for the secrétaire in a depth of 30 cm can also be positioned in *2, *3, *4, and *5 positions from the top and will always be permanently fitted.

Please note that the shelf is shortened to accommodate the hinge for the flap and is mounted on glass brackets (pins).

The bar unit is equipped with a mirrored rear panel and a black glass bottom applied to the drop front door.





Bar unit

69.6 cm
(*12)

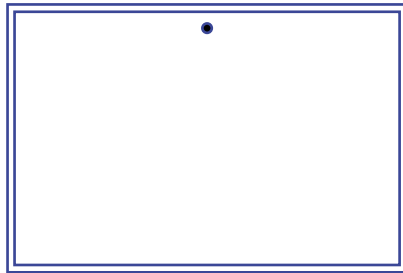

46.8 cm
(*8)

4118

Fitted with mirrored back panel, black glass shelf door and LED spots which turn on when the front is opened. The spots are dimmable and can be regulated through a kinetic switch.

Cables and transformer is included and can be concealed in the rear panel.

Max load module: 30 kg

Max load on drop front door: 10 kg

Internal dimensions
(behind door)

30 cm	22.5 cm
38 cm	30.5 cm

Secrétaire

69.6 cm
(*12)

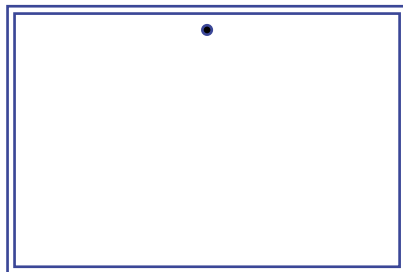

46.8 cm
(*8)

4119

Can be supplied with cable grommets and can be fitted with LED spot. Shelf can be fitted behind the drop front in depth 38 (30.5 cm.)

Max load module: 30 kg

Max load on drop front door: 10 kg

Internal dimensions
(behind door)

30 cm	25.5 cm
38 cm	33.5 cm



MONTANA
Studio and Secrétaire



Studio

69.6 cm
(*12)

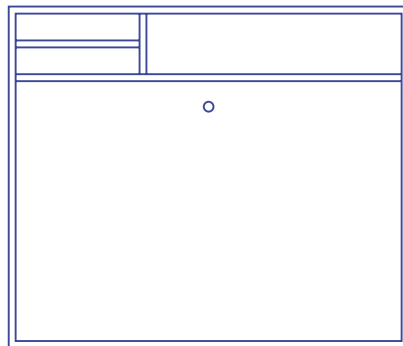

58.2 cm
(*10)

Is equipped with magnetic notice board that comes with 5 magnets. The secretary has a shelf and two small trays.

Is delivered with coloured handles.

Max load module: 30 kg
Max load on door: 10 kg.

Internal dimensions
(behind door)

30 cm 25.5 cm



POSITION





Suspension rails

The OP12 (12 mm thick) is equipped with fittings for horizontal adjustment of the unit. It includes adjustable spacer knobs, which allow alignment with the wall. Modules with heights *2, *3, and *4 are reinforced with an additional metal bracket, OPSK.

Modules with a height of *2 and widths of *12 or *8 are supplied with metal support brackets at each corner, along with metal knobs for wall suspension, referred to as OPXS.

For modules where cords need to pass through the suspension bracket, the OPLYD is available in both 12 mm and 16 mm thicknesses. The OPLYD is a divided rail that provides a passage for cords and wires.



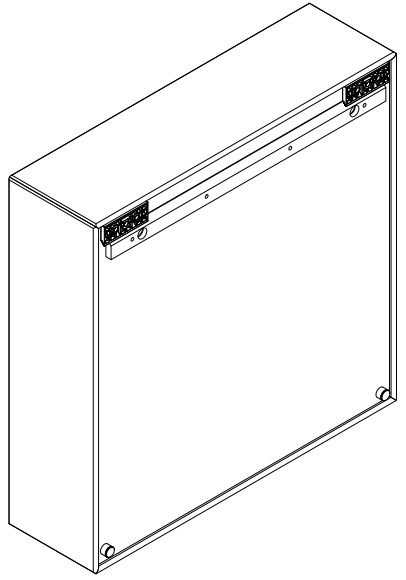

MONTANA SUSPENSION RAIL
Mounting tutorial on YouTube



Plinths

Height: 3 and 7 cm (8-46 cm)

Width: is indicated with the star measurement.

Depth: 2-4 cm shorter than the actual depth of the module to allow space for skirting boards.

Plinths are connected and levelled before placing the modules. All plinths are fitted with adjustable feet on each side.

Installation of plinths under modules with a depth of 20 cm with door is at the customer's own risk.



MONTANA SYSTEM

Plinth



MONTANA SYSTEM

Plinth



Legs

Height: 12.6 cm (height-adjustable feet up to 20 mm)

Colours: Matt chrome, brass and all 41 Montana lacquer colours.

Units: Suited from width 24 cm (*4) to 69.6 cm (*12). Units in width 69.6 cm (*12) must always be fitted with a suspension rail SS60 under the bottom panel.

Mounting: Bushings for mounting included. Legs cannot be mounted under modules with depth 20 cm.

Max load for a set of legs (min. 4): 75 kg



MONTANA
Legs in 43 colours



MONTANA
Legs in brass colour



Castors

CR70 castors (2 castors are fitted with brakes)

Height: 6.8 cm

CR70 fits plinths of height 7 cm

Colour: Grey/black or black/black

Max load for a set of castors: 80 kg



Castors

CR Castors (All castors are fitted with brakes)

Height: 8.9 cm

Colour/Material: Grey/black or black/black/
Plastic castor and soft tracking surface

Max load for a set of castors: 80 kg



Castors

SR castors (All castors are fitted with brakes)

Height: 10 cm

Colour/material: Grey/rubber

Max load for a set of castors: 80 kg



Castors

SRCO Castors (All 4 castors are fitted with brakes)

Height: 7.8 cm

Colour/material: Plastic castors with brake and lacquered castor cover, available in all Montana lacquer colours

SRCO cannot be fitted under width *21 units

Max load for a set of castors: 80 kg

D: 20 cm units cannot be fitted with castors.

Units in width *12 or wider with castors should be fitted with support rail SS60.



MONTANA SYSTEM

Left: CR70 caster / Right: SRCO castor



MONTANA SYSTEM

SR castors mounted on base plate



Stacking height

For security reasons and to maximise the modules' weight capacity, DesignPro will automatically add suspension rails to stacked modules exceeding a height of *24 or 139.2 cm that are not already wall-mounted.

Selected products are exempt from this rule.





COMPONENTS





MONTANA SYSTEM

Glass doors are available as transparent, lacquered and with rippled surface.



MONTANA SYTEM
Glass doors with handles



MONTANA SYTEM

Pre-configured modules with rippled glass are delivered with MDF shelves on that can easily be moved around.



MONTANA SYSTEM

Rippled glass doors cannot be lacquered





MONTANA SYSTEM

Push drawers and drawers with 100% pull out. All drawers are hand built in white pigmented solid wood



MONTANA SYSTEM
Drawer trays & trays



MONTANA SYSTEM

Push doors and seating option on plinth. Cushions can be ordered in standard measurements *12, * 24 and *36 – Depth 38 cm



Handles

G1 Cylindrical with finger grip

L: 16 mm, Ø12 mm

Available in aluminum, brass and in all Montana lacquer colours.

G7 Cylindrical handle with disc in clear acrylic.

L: 16 mm, Ø12 mm

Available in all Montana lacquer colours.



MONTANA
Handles G1 and G7



Lights

The Montana System can be supplied with 12V LED recessed spot Ø55 in matt steel colour. 12.4 wattage.

The LED spot has a built-in dimmable function and is regulated by a switch. The LED spot switch is powered by kinetic energy and does not require a battery.

The LED has mood lighting and can be adjusted from cool to warm light (Kelvin 2100K to 6500K). CRI above 95. Lumen 160. Expected lifetime for a LED spot app. 30.000 hours.

The spots can be controlled via a WIFI Controller (Smart Life, App, Alexa, Google Chrome etc.)

Remember to add transformer TLED12 for 1-8 spots. Approved for CE and UKCA.



MONTANA SYSTEM

CABLE D Cable grommet – Ø60 mm – can be placed in the backpanel of a module.

The default colour is aluminum but can be ordered in all 41 lacquer colours.



MONTANA

USB Micro power dot (USB C) can be mounted on drawers or cabinets



MONTANA
Drawer divider



Top plates

Top plates are available in 12 mm MDF in 41 colours or in glass – low iron (not hardened) – in standard or custom sizes.

The front and rear edges are rounded, while the end edges are straight. When a top plate needs to cover multiple units, an additional 1 mm is calculated per unit.



MDF 12 mm standard

TOP105	W 105.2 CM (*18: *12 + *6)
TOP139	W 139.4 CM (*24: *12 + *12)
TOP174	W 174.9 CM (*30: *12 + *6 + *12)
TOP209	W 209.1 CM (*36: *12 + *12 + *12)

MDF 12 mm special dimensions

TOP12M	L 0 - 240 CM
	D 0-60 CM

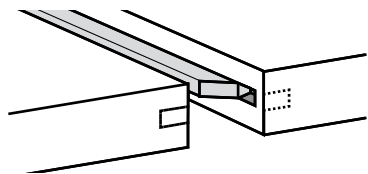

SAMNOT Tongue & groove

Glass 12 mm standard

TGL12	W 169.6 CM (*12)
TGL06	W 35.4 CM (*6)
TGL24	W 139.4 CM (*24: *12 + *12)
TGL16	W 93.8 CM (*16: *8 + *8)
TGL08	W 46.8 CM (*8)

Glass 12 mm special dimensions

TOP12G	L 0 - 270 CM
	D 0 - 120
	Depth 91-120 is not available in L 180-300



KANTA (Both sides are rounded)





Living things

Here's the revised version in UK English:

The Living Things plant box is available in eight different sizes and can be purchased with or without a fixed divider, creating two compartments that allow the module to be used for both plants and items such as magazines.

The plant boxes are made from 12 mm MDF and are available in all of Montana's lacquer colours. Each module has a reinforced base and can be configured with castors, legs, or stacked on top of other modules.

All Living Things modules include a plastic insert and adhesive non-slip pads.



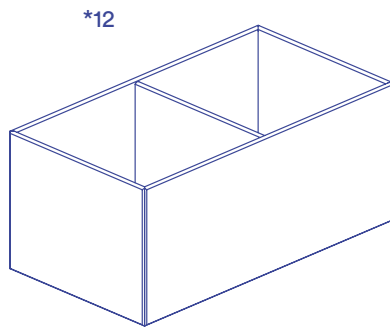

LT3812
H 30 CM / W 69.6 CM
D 38 CM

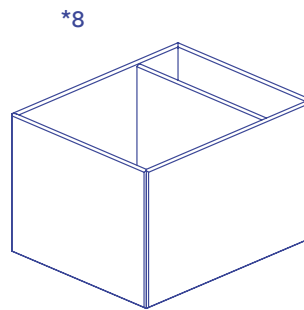

LT3842
H 30 CM / W 46.8 CM
D 38 CM

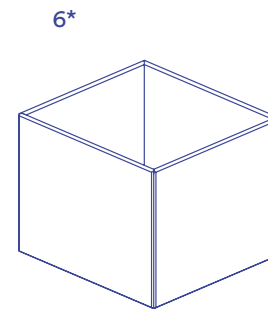

LT3861
H 30 CM / W 35.4 CM
D 38 CM

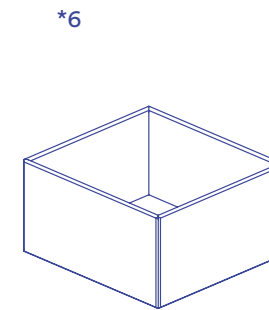

LT3861
H 20 CM / W 35.4 CM
D 38 CM

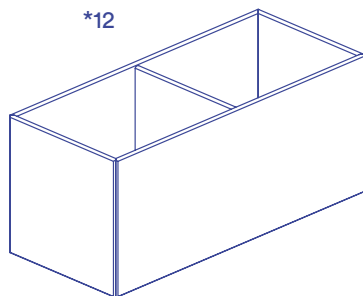

LT3012
H 30 CM / W 69.6 CM
D 30 CM

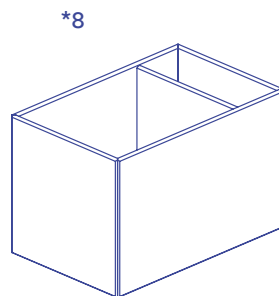

LT3042
H 30 CM / W 46.8 CM
D 30 CM

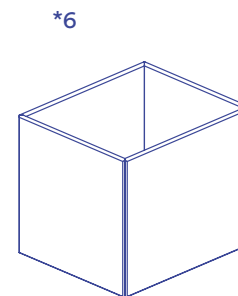

LT3061
H 30 CM / W 35.4 CM
D 30 CM

MONTANA LIVING THINGS

Living things can be configured with Montana system in DesignPro



MONTANA

Living things can be configured with Montana system in DesignPro



Sliding doors

The doors can slide together on either the left or right side of the unit. The unit includes a centrally placed vertical divider behind the doors. Shelves in units with sliding doors, with depths of 20 cm and 30 cm, are fixed.

The L6 lock is designed for sliding doors and is a system lock compatible with L1. It is locked by pushing the core and turning it. Sandwich handles are only available in aluminium.

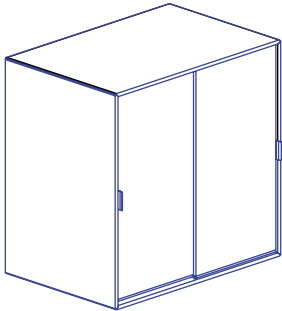

Effective shelf depths
(behind door)

- 20 cm
- 30 cm
- 38 cm
- 46.8 cm



COLOURS







Black Zone	White Zone	Urban Nature	Candy	Coco	Global	Manga
02 Fjord	101 New White	104 Milk	109 Lemon Drop	115 Boulevard	121 Madras	125 Tokyo Yellow
100 Graphic	101 New White Gloss	105 Lounge	110 Peach	116 Cabernet	48 Burma	126 Yoko Orange
04 Anthracite	38 Snow	106 Latte	111 Candy Floss	117 Moulin Rouge	10 China Red	127 Zen Red
36 Coal	01 White	35 Coffee	112 Violetta	118 Montparnasse	122 Rio	128 Ginza Pink
65 Black Snow	103 Frost	107 Air	113 Peppermint	119 Royale	123 Marocco	129 Kyoto Blue
05 Black	09 Nordic	108 Green Tea	114 Pistachio	120 Botanique	124 Amazonas	120 Umami Green
64 Soft Black	133 Black Oak	132 Burned Oak	131 White Oak	134 Brocade	43 Aluminium	98 Calendered Glass

The replenishment guarantee makes Montana products a sound, long-term investment.

Montana offers replenishment on the 2011-2019 colours two times a year against an additional fee.

Supplied in week 14 (please order before 1st feb) and week 40 (please order before 1st August). Additional cost 30%.

Please note there may be variations in lacquer shades as a result of new technology and raw materials.



MONTANA
Veneer

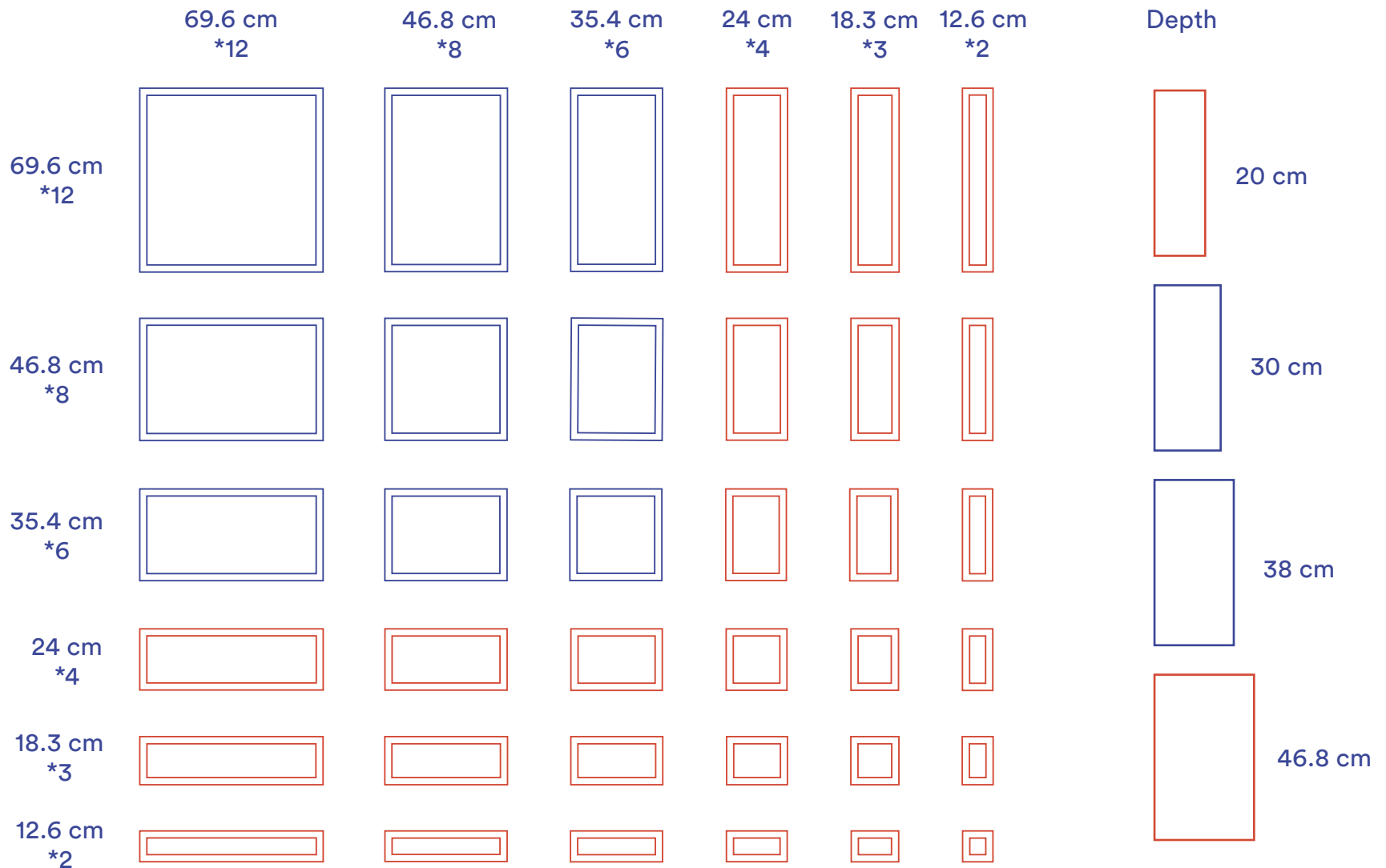



TECHNICAL INFO

Technical info

Load capacity, support rails, the *system, and pilot holes – all are important considerations when building a Montana shelving composition.





Stacking capacity

All modules are supplied with adhesive non-slip pads, allowing them to be stacked without invasive holes or connectors. This ensures the modules remain future-proof for alternative uses and functions. DesignPro will automatically add suspension rails to modules exceeding *24 or 139.2 cm in height when placed on a base of modules with either a plinth, legs, or castors. This enhances stability, safety, and weight capacity.

Specific information for modules on castors:

Depth 30/38 cm: Maximum stacking height is 105 cm.

Depth 46.8 cm: Maximum stacking height is *12/139.6 cm.

Specific information for modules on legs:

A maximum of two *12 modules or 139.2 cm in height is allowed, with a maximum load capacity of 75 kg.





Load capacity

Mounted shelving units with heights in multiples of *12, *8, and *6 and depths of 20, 30, and 38 cm can support a load of up to 40 kg, provided the wall composition and the mounting method allow for it.

Shelving units with heights in multiples of *4, *3, and *2 and a depth of 46.8 cm have a lower weight capacity and should only be loaded with up to 10 kg.

Please note that units with a width of *12, without a vertical partition, can only support a load of 3 kg unless a support rail (SS10) is used. Similarly, shelves with the same width can only support a load of 3 kg without the use of a support rail SS10.



Load capacity for modules on suspension rail

Height	Width	*12 with vertical partition 69.6 cm	*12 without vertical partition 69.6 cm with support rail SS10	*8	*6	*4	*3	*2	
				46.8 cm	35.4 cm	24 cm	18.3 cm	12.6 cm	
*12	D20	40 kg	10 kg	40 kg	40 kg	40 kg	40 kg	40 kg	
	D30	40 kg		40 kg	40 kg	40 kg	40 kg	40 kg	
	D38	40 kg		40 kg	40 kg	40 kg	40 kg	40 kg	
	D46.8	20 kg		20 kg	20 kg	20 kg	20 kg		
*8	D20	40 kg		40 kg	40 kg	40 kg	40 kg	40 kg	40 kg
	D30	40 kg		40 kg	40 kg	40 kg	40 kg	40 kg	40 kg
	D38	40 kg		40 kg	40 kg	40 kg	40 kg	40 kg	40 kg
	D46.8	20 kg		20 kg	20 kg	20 kg	20 kg	20 kg	
*6	D20	40 kg		40 kg	40 kg	40 kg	40 kg	40 kg	40 kg
	D30	40 kg		40 kg	40 kg	40 kg	40 kg	40 kg	40 kg
	D38	40 kg		40 kg	40 kg	40 kg	40 kg	40 kg	40 kg
	D46.8	20 kg		20 kg	20 kg	20 kg	20 kg	20 kg	
*4	D20	10 kg	10 kg	10 kg	10 kg	10 kg	10 kg	10 kg	
	D30	10 kg	10 kg	10 kg	10 kg	10 kg	10 kg	10 kg	
	D38	10 kg	10 kg	10 kg	10 kg	10 kg	10 kg	10 kg	
	D46.8	10 kg	10 kg	10 kg	10 kg	10 kg	10 kg		
*3	D20	10 kg	10 kg	10 kg	10 kg	10 kg	10 kg	10 kg	
	D30	10 kg	10 kg	10 kg	10 kg	10 kg	10 kg	10 kg	
	D38	10 kg	10 kg	10 kg	10 kg	10 kg	10 kg	10 kg	
	D46.8	10 kg	10 kg	10 kg	10 kg	10 kg	10 kg		
*2	D20	10 kg	10 kg	10 kg	10 kg	10 kg	10 kg	10 kg	
	D30	10 kg	10 kg	10 kg	10 kg	10 kg	10 kg	10 kg	
	D38	10 kg	10 kg	10 kg	10 kg	10 kg	10 kg	10 kg	
	D46.8	10 kg	10 kg	10 kg	10 kg	10 kg	10 kg		



Load capacity for modules on plinth

Height	Width	*12 with vertical partition 69.6 cm	*12 without vertical partition 69.6 cm with support rail SS10	*8 46.8 cm	*6 35.4 cm	*4 24 cm	*3 18.3 cm	*2 12.6 cm		
*12	D20	60 kg	10 kg	60 kg	60 kg	60 kg	60 kg	60 kg		
	D30	60 kg		60 kg	60 kg	60 kg	60 kg	60 kg		
	D38	60 kg		60 kg	60 kg	60 kg	60 kg	60 kg		
	D46.8	40 kg		40 kg	40 kg	40 kg	40 kg	40 kg		
*8	D20	60 kg		10 kg	60 kg	60 kg	60 kg	60 kg	60 kg	
	D30	60 kg			60 kg	60 kg	60 kg	60 kg	60 kg	
	D38	60 kg			60 kg	60 kg	60 kg	60 kg	60 kg	
	D46.8	40 kg			40 kg	40 kg	40 kg	40 kg	40 kg	
*6	D20	60 kg			10 kg	60 kg	60 kg	60 kg	60 kg	60 kg
	D30	60 kg				60 kg	60 kg	60 kg	60 kg	60 kg
	D38	60 kg				60 kg	60 kg	60 kg	60 kg	60 kg
	D46.8	40 kg				40 kg	40 kg	40 kg	40 kg	40 kg
*4	D20	40 kg	10 kg			40 kg	40 kg	40 kg	40 kg	40 kg
	D30	40 kg				40 kg	40 kg	40 kg	40 kg	40 kg
	D38	40 kg				40 kg	40 kg	40 kg	40 kg	40 kg
	D46.8	40 kg				40 kg	40 kg	40 kg	40 kg	40 kg
*3	D20	40 kg		10 kg		40 kg	40 kg	40 kg	40 kg	40 kg
	D30	40 kg				40 kg	40 kg	40 kg	40 kg	40 kg
	D38	40 kg				40 kg	40 kg	40 kg	40 kg	40 kg
	D46.8	40 kg				40 kg	40 kg	40 kg	40 kg	40 kg
*2	D20	40 kg			10 kg	40 kg	40 kg	40 kg	40 kg	40 kg
	D30	40 kg				40 kg	40 kg	40 kg	40 kg	40 kg
	D38	40 kg				40 kg	40 kg	40 kg	40 kg	40 kg
	D46.8	40 kg				40 kg	40 kg	40 kg	40 kg	40 kg



Load capacity for modules on legs - max. load for one set of legs : 75 kg

Height	Width	*12 with vertical partition and SS60 69.6 cm	*12 without vertical partition 69.6 cm with support rail SS10	*8	*6	*4	*3	*2		
*12	D20	50 kg	10 kg	50 kg	50 kg	50 kg	50 kg	50 kg		
	D30	50 kg		50 kg	50 kg	50 kg	50 kg	50 kg		
	D38	50 kg		50 kg	50 kg	50 kg	50 kg	50 kg		
	D46.8	50 kg		50 kg	50 kg	50 kg	50 kg	50 kg		
*8	D20	50 kg		10 kg	50 kg	50 kg	50 kg	50 kg	50 kg	
	D30	50 kg			50 kg	50 kg	50 kg	50 kg	50 kg	
	D38	50 kg			50 kg	50 kg	50 kg	50 kg	50 kg	
	D46.8	50 kg			50 kg	50 kg	50 kg	50 kg	50 kg	
*6	D20	50 kg			10 kg	50 kg	50 kg	50 kg	50 kg	50 kg
	D30	50 kg				50 kg	50 kg	50 kg	50 kg	50 kg
	D38	50 kg				50 kg	50 kg	50 kg	50 kg	50 kg
	D46.8	50 kg				50 kg	50 kg	50 kg	50 kg	50 kg
*4	D20	50 kg	10 kg			50 kg	50 kg	50 kg	50 kg	50 kg
	D30	50 kg				50 kg	50 kg	50 kg	50 kg	50 kg
	D38	50 kg				50 kg	50 kg	50 kg	50 kg	50 kg
	D46.8	50 kg				50 kg	50 kg	50 kg	50 kg	50 kg
*3	D20	50 kg		10 kg		50 kg	50 kg	50 kg	50 kg	50 kg
	D30	50 kg				50 kg	50 kg	50 kg	50 kg	50 kg
	D38	50 kg				50 kg	50 kg	50 kg	50 kg	50 kg
	D46.8	50 kg				50 kg	50 kg	50 kg	50 kg	50 kg
*2	D20	50 kg			10 kg	50 kg	50 kg	50 kg	50 kg	50 kg
	D30	50 kg				50 kg	50 kg	50 kg	50 kg	50 kg
	D38	50 kg				50 kg	50 kg	50 kg	50 kg	50 kg
	D46.8	50 kg				50 kg	50 kg	50 kg	50 kg	50 kg



Load capacity for modules on castors

Height	Width	*12 with vertical partition and SS60 69.6 cm	*12 without vertical partition 69.6 cm with support rail SS10	*8	*6	*4	*3	*2	
				46.8 cm	35.4 cm	24 cm	18.3 cm	12.6 cm	
*12	D20	80 kg	10 kg	80 kg	80 kg	80 kg	80 kg	80 kg	
	D30	80 kg		80 kg	80 kg	80 kg	80 kg	80 kg	
	D38	80 kg		80 kg	80 kg	80 kg	80 kg	80 kg	
	D46.8	80 kg		80 kg	80 kg	80 kg	80 kg		
*8	D20	80 kg		80 kg	80 kg	80 kg	80 kg	80 kg	80 kg
	D30	80 kg		80 kg	80 kg	80 kg	80 kg	80 kg	80 kg
	D38	80 kg		80 kg	80 kg	80 kg	80 kg	80 kg	80 kg
	D46.8	80 kg		80 kg	80 kg	80 kg	80 kg	80 kg	
*6	D20	80 kg		80 kg	80 kg	80 kg	80 kg	80 kg	80 kg
	D30	80 kg		80 kg	80 kg	80 kg	80 kg	80 kg	80 kg
	D38	80 kg		80 kg	80 kg	80 kg	80 kg	80 kg	80 kg
	D46.8	80 kg		80 kg	80 kg	80 kg	80 kg	80 kg	
*4	D20	80 kg	80 kg	80 kg	80 kg	80 kg	80 kg	80 kg	
	D30	80 kg	80 kg	80 kg	80 kg	80 kg	80 kg	80 kg	
	D38	80 kg	80 kg	80 kg	80 kg	80 kg	80 kg	80 kg	
	D46.8	80 kg	80 kg	80 kg	80 kg	80 kg	80 kg		
*3	D20	80 kg	80 kg	80 kg	80 kg	80 kg	80 kg	80 kg	
	D30	80 kg	80 kg	80 kg	80 kg	80 kg	80 kg	80 kg	
	D38	80 kg	80 kg	80 kg	80 kg	80 kg	80 kg	80 kg	
	D46.8	80 kg	80 kg	80 kg	80 kg	80 kg	80 kg		
*2	D20	80 kg	80 kg	80 kg	80 kg	80 kg	80 kg	80 kg	
	D30	80 kg	80 kg	80 kg	80 kg	80 kg	80 kg	80 kg	
	D38	80 kg	80 kg	80 kg	80 kg	80 kg	80 kg	80 kg	
	D46.8	80 kg	80 kg	80 kg	80 kg	80 kg	80 kg		



Support rails

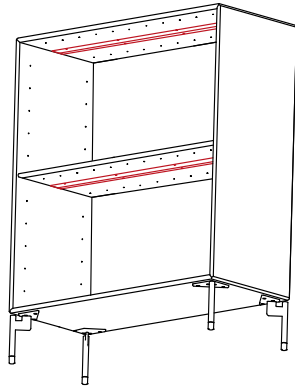

SS10

Support rail for shelving units without vertical dividers should be selected for loads of more than 3 kg.

Shelves/units can withstand a total load of max. 10 kg with a support rail. The support rail comes in the same colours as the shelving unit.

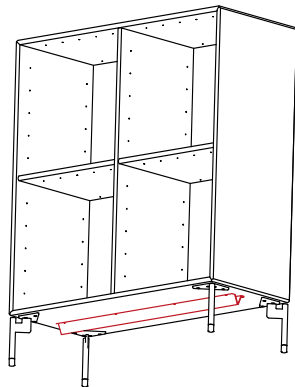

SS60

Support rail for mounting under units *12 and up, with Montana legs and castors.

When legs and castors are purchased for retrofitting for a module *12 or bigger, a SS60 should also be purchased and assembled.

The support rail comes in the same colours as the unit.

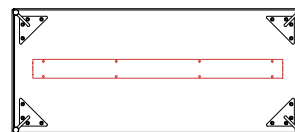



Generations

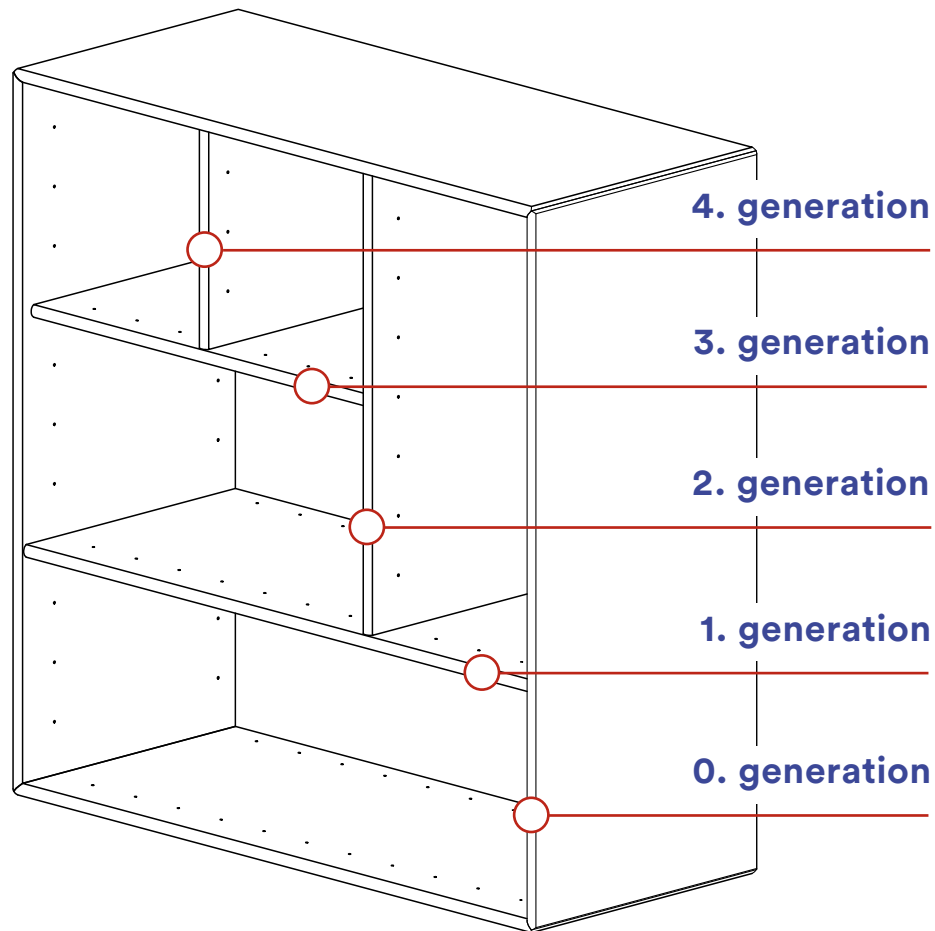

When building a Montana composition, it is important to consider the different generations. Each generation has its own depth, as each shelf is positioned 2 mm further back than the one it is fastened to.

When ordering loose components, such as shelves, DesignPro will prompt you to specify the generation or whether the shelf is located behind a door.



*6 + *6 is not *12

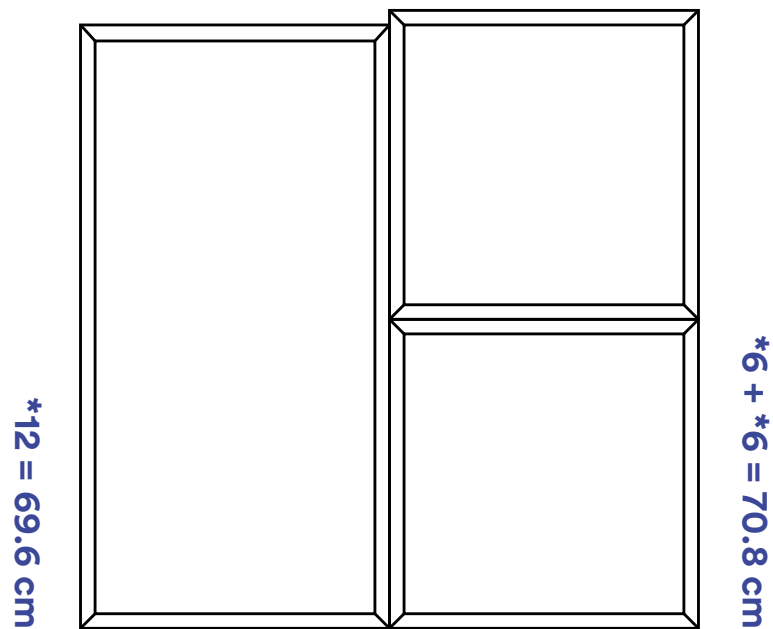

When placing two modules with a height of *6 on top of each other next to a module with a height of *12, you will notice a discrepancy of 12 mm, as they will not align flush.

For this reason, it is important to use an even number of modules in both height and width when creating a composition.



Internal dimensions of drawers

Width	*6 297 mm	*7 354 mm	*8 411 mm	*12 639 mm
Depth	D30 233 mm	D38 313 mm	D46.8 401 mm	
Height	H2	H3	H4	H6
Casing inner side	50 mm	108 mm	108 mm	177 mm
Front inner	66 mm	123 mm	180 mm	292 mm
Front inner + shade list	78 mm	135 mm	192 mm	304 mm
Height outer	H2	H3	H4	H6
Front	99 mm	156 mm	213 mm	325 mm
Front with shade list	111 mm	168 mm	225 mm	337 mm



Internal depth

Unit depth	Open units	Behind doors
20 cm	18.7 cm	16.1 cm
30 cm	28.7 cm	26.1 cm
38 cm	36.7 cm	34.1 cm
46.8 cm	45.5 cm	42.9 cm





EU Ecolabel

The EU Ecolabel is a mark of environmental excellence, recognised across Europe and globally.

It is awarded to products that meet high environmental standards throughout their life cycle, ensuring less waste and reduced CO2 emissions during production. These products are durable, easy to repair, and recyclable, embodying quality and thoughtful design.

The EU Ecolabel establishes stringent guidelines and ensures compliance through third-party controls and audits.



Unique selling points

- Danish design
- Made in Denmark
- 10 year guarantee
- EU Ecolabel
- Made to order
- High quality craftsmanship
- Environment-friendly
- Uniquely created colours
- Endless possibilities
- Total flexibility
- Timeless and modern



Always updated on

Montana Website

Montana Digital Showroom

Peter Lassen Video

Online training module

